

Bagged stonedust barriers

Contents

Bagged stonedust barriers 2

Specification for a bagged stonedust barrier to the extension of flame 2

Types of barrier 4

Specification for a conventional stone dust barrier to the extension of the flame 10

Specification for a passive water trough barrier to the extension of flame 12

Appendix I 16

Appendix II 17

Appendix III 18

Bagged stonedust barriers

Specification for a bagged stonedust barrier to the extension of flame

Common barrier constraints

- 1 The barrier should consist of a number of isotropic plastic bags containing 6kg of stonedust suspended in the roadway and arranged in accordance with this schedule.
- 2 All bags and hooks used in the construction of any barrier to the extension of a flame should be of a suitable type.
- 3 Any stonedust used in the construction of any barrier to the extension of a flame should be of a suitable type
- 4 Each bag that forms any part of the barrier should contain a minimum 6 kg of stonedust and be hung with the largest cross sectional area of the bag facing the potential blast wave (Diagram 1)
- 5 The horizontal distance between hooks of bags in the same row must not be less than 0.4 metres and not greater than 1.0 metre.
- 6 The distance between the outer bags and the sides of the roadways must not exceed 0.5 metres.
- 7 For roadways up to 3.5 metres high one layer of bags per row is required, they should be suspended with the hooks between 0 metres and 0.5 metres from the roof. The bags should be installed to follow the roadway profile.
- 8 For roadways between 3.5 metres high and 4.5 metres high, two layers of bags per row are required. The bags should be evenly distributed between the layers with the hooks suspended between 0 metres and 0.5 metres from the roof in layer one and between 0.5 metres and 1.0 metres from the roof in layer two (Diagram 2).
- 9 For roadways greater than 4.5 metres high three layers of bags per row are required. The bags should be evenly distributed between the layers with the hooks suspended between 0 metres and 0.5 metres from the roof in layer one, between 0.5 metres and 1.0 metre from the roof in layer two and between 1 metre and 1.5 metres from the roof in layer three.
- 10 The distance between each row of bags within a sub barrier or within a distributed barrier should not be less than 1.5 metres and not be greater than 3 metres.

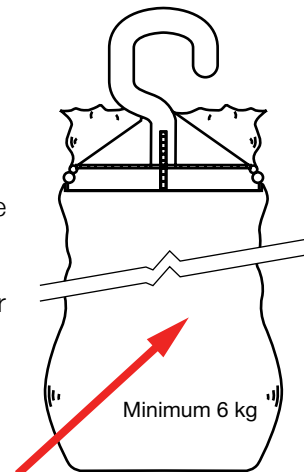

Direction of blast wave

Diagram 1 Bags suspended facing the direction of any blast waves

11 Where any type of bagged barrier is used to provide explosion protection in a conveyor roadway additional bags (to those required for the standard barrier) should be suspended beneath the conveyor structure to provide additional protection against passage of a flame under the belt. In circumstances where a conveyor is wider than 2m and there is more than 1m between the conveyor and

the floor of the roadway, then one additional bag per metre width of the conveyor should be installed beneath the conveyor for each row of bags suspended in that roadway.

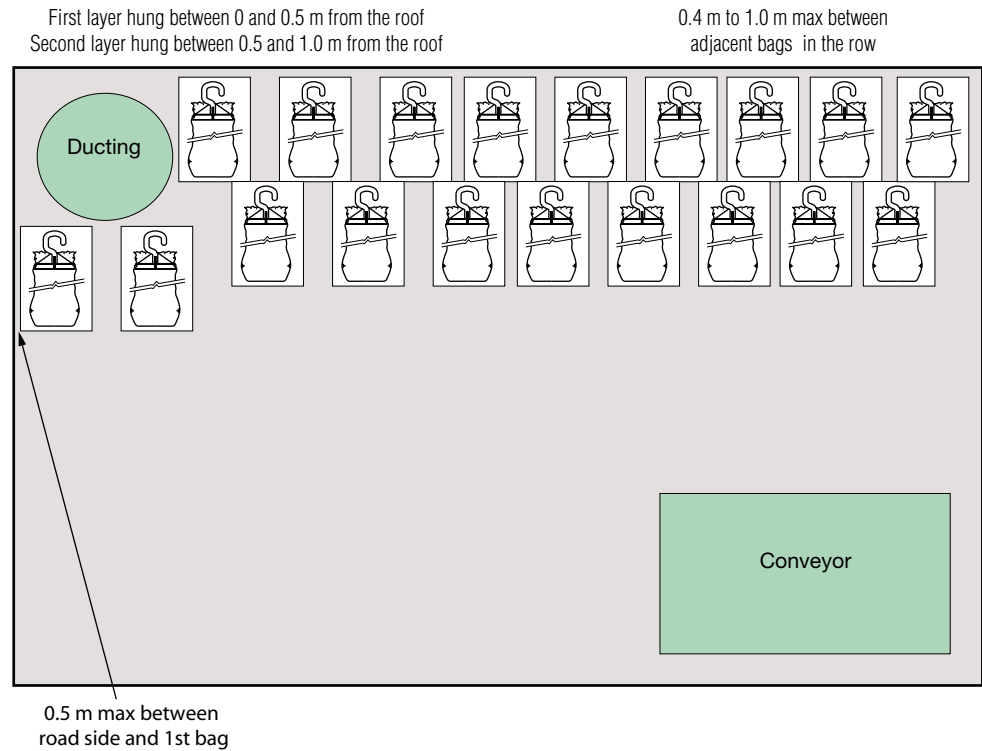

Diagram 2 to show more than one layer of bags in a roadway between 3.5 and 4.5 m high

12 Notwithstanding paragraphs 7, 8 and 9 above where the bagged barrier is used to provide explosion protection in a roadway and a ventilation system (ducting, fans, regulators 'T' pieces etc.) is suspended from the roof, the bags that would have been suspended from the roof where the ventilation system is suspended should be suspended below the system at the specified intervals (Diagram 3).

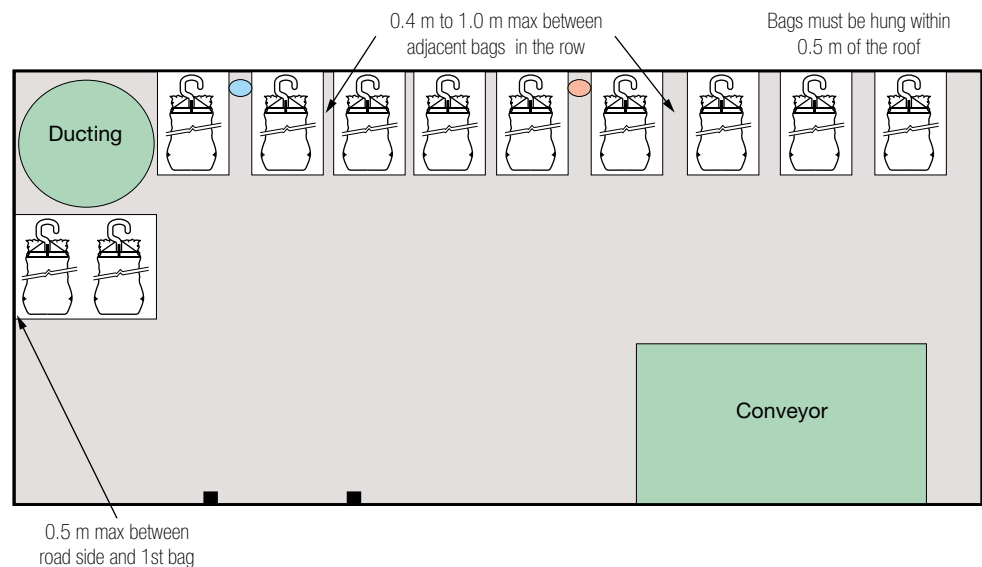

Diagram 3 to show bags suspended round a roadway obstruction

Types of barrier

Primary Barrier

13 The primary barrier should consist of four identical sub barriers installed over a distance of 120 metres of continuous roadway.

14 The first row of bags in the primary barrier should not be closer than 70m and not be further than 120m from the coalface, face of heading or other potential ignition source (see paragraph 31), as appropriate.

15 The middle two sub barriers should be spaced equidistant between the first and fourth sub barriers.

16 To ensure the minimum stonedust requirement is in place during retreating/advancing of the barrier an additional (fifth) sub barrier should be used; this should be installed before the first sub barrier is out of distance with the working place it is protecting.

17 The stonedust requirement for the complete primary barrier should be calculated to achieve a stone dust density of 1.2 kg/m³

Worked Example

Roadway size: 5m wide x 3.2m high.

Volume of roadway = 5m x 3.2m x 120m = 1920m³

Therefore stonedust required in barrier is 1920m³ x 1.2 kg/m³ = 2304kg of stonedust in the barrier.

Number of 6 kg bags to barrier: 2304/6 = 384 bags.

Number of bags per sub barrier: 384/4 = 96 bags.

If bags are hung 0.5m from the sides of the roadway and 0.4m apart then each row will contain 11 bags.

This example shows each sub barrier should contain a minimum of 96 bags, if each sub barrier consists of 9 rows of 11 bags a total of 99 bags would be used therefore satisfying the minimum requirement.

If each row is spaced 1.5m apart then each sub barrier will extend over a distance of 12m (Fig.1).

Secondary Barrier

18 The secondary barrier should consist of two identical sub barriers and be installed over a distance of 120m of continuous roadway.

19 The first row of bags in the secondary barrier should not be closer than 70m and not be further than 120m from the last row of bags in the primary barrier.

20 To ensure the minimum stonedust requirement is in place during retreating/advancing of the barrier an additional (third) sub barrier should be used; this should be installed before the first sub barrier is out of distance with the working place it is protecting.

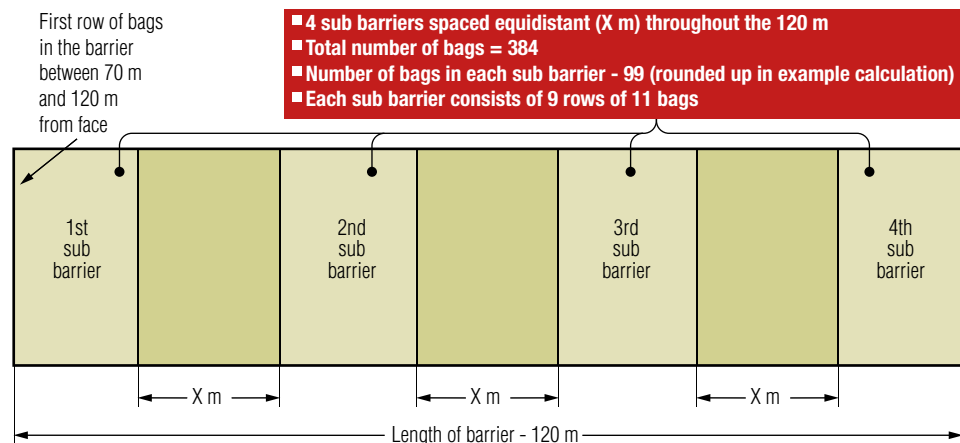

Figure 1 to show distribution of sub barriers in a primary barrier as in the worked example

21 The stonedust requirement for the complete secondary barrier should be double that required for a primary barrier in the same roadway.

Worked Example

Roadway size: 5m wide x 3.2m high.

Volume of roadway = $5\text{m} \times 3.2\text{m} \times 120\text{m} = 1920\text{m}^3$

Therefore, stonedust required $1920\text{m}^3 \times 1.2\text{kg}/\text{m}^3 \times 2 = 4608\text{kg}$.

Number of 6 kg bags to barrier: $4608/6 = 768$ bags.

Number of bags per sub barrier: $768/2 = 384$ bags.

If bags were hung 0.3m from the sides of the roadway and 0.4m apart then each row would contain 12 bags.

The sub barrier would consist of 32 rows of 12 bags. If each row is spaced 1.5m apart then each sub barrier will extend over a distance of 46.5m.

The second sub barrier would contain exactly the same number of bags and layout as the first (Fig.2).

Distributed Barrier

22 The distributed barrier consists of rows of bags being installed and being left in place until the mining operations it is protecting against are complete.

23 The first row of bags should not be closer than 70m and not be further than 120m from the working face. Bags may be hung closer than 70m but will not be deemed to form part of the barrier.

24 The distributed barrier must be at least 360m long. The distance of 360m gives the same mass of stonedust as a primary and secondary barrier for the same cross sectional area.

25 The stonedust requirement for a fixed distributed barrier should be calculated to achieve a stonedust density of $1.2\text{kg}/\text{m}^3$ of roadway volume.

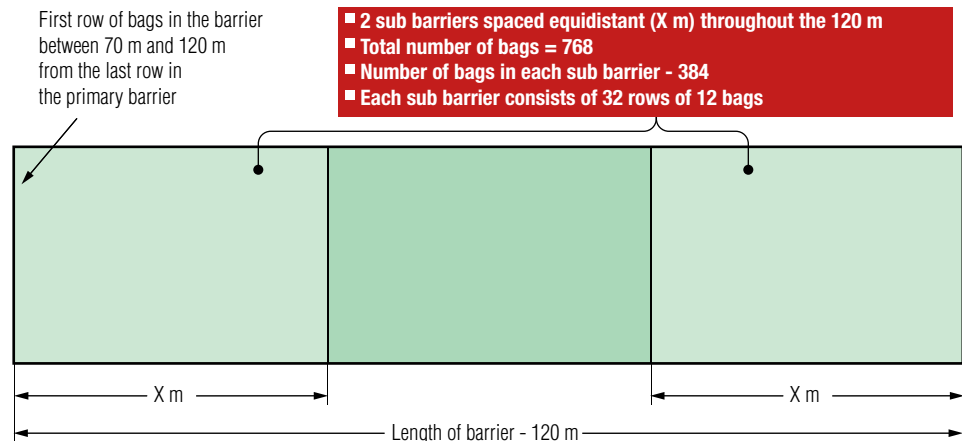

Figure 2 to show distribution of sub barriers in a secondary barrier as in the worked example

Worked Example

Roadway volume: $5\text{m} \times 3.2\text{m} \times 360\text{m} = 5760\text{m}^3$

Therefore stonedust required in barrier is $5760\text{m}^3 \times 1.2\text{kg}/\text{m}^3 = 6912\text{kg}$.

Number of 6 kg bags $6912/6 = 1152$ bags.

Number of bags per metre = $1152/360 = 3.2$ bags.

If the rows are spaced at 3m intervals then $3.2 \text{ bags} \times 3\text{m} = 9.6$ bags per 3 metres

One row of 10 bags for every 3m of roadway length (Fig.3)

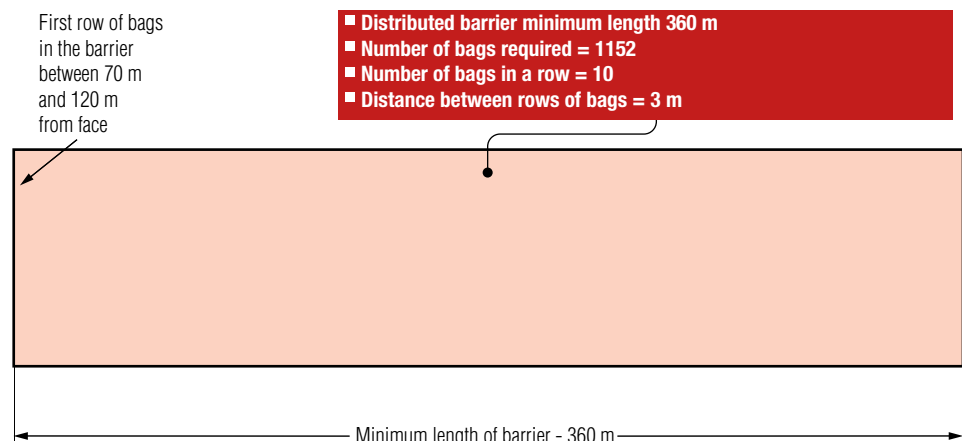

Figure 3 to show distribution of bags in a distributed barrier as in the worked example

Longwall Workings, Headings in Coal and Bord and Pillar Workings

26 The conveyor roadway of any such working should be protected by either:

- (a) primary and secondary barriers installed at the distances specified, (Fig. 4, 4a & 4b) or
- (b) a distributed barrier installed at the distances specified (Fig. 5, 5a, & 5b)

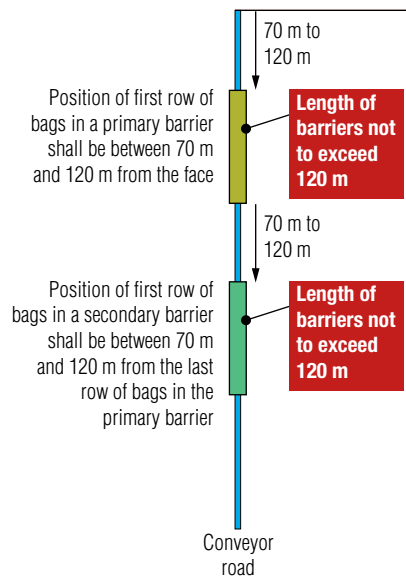

Figure 4 Protection of an established coal face using primary and secondary bunkers

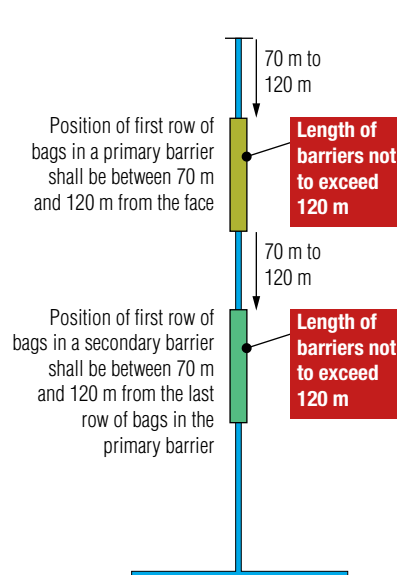

Figure 4a Protection of an established heading in coal using primary and secondary barriers

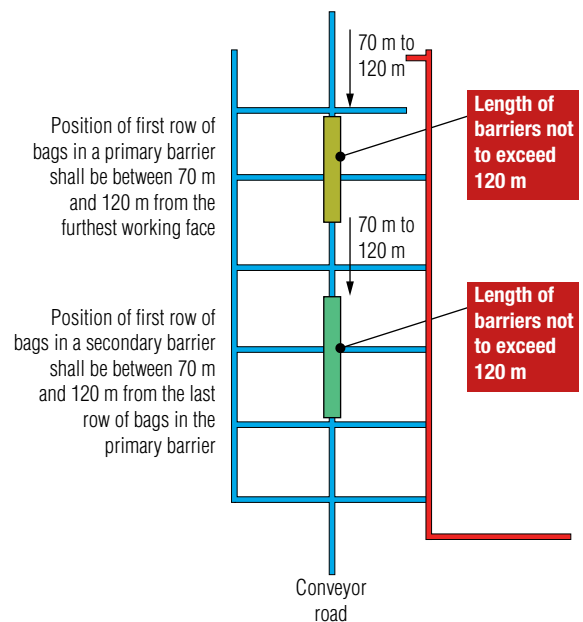

Figure 4b Protection of an established bord and pillar working using primary and secondary barriers

27 Where a coal face, a heading in coal or a bord and pillar working is advancing from or retreating towards a junction with an adjoining roadway, the primary and secondary barriers or the distributed barrier (whichever the case) should be maintained within the distances stipulated in this specification (Fig. 6, 6a & 6b).

Establishing New Working Areas/Completing Working Areas (Fig 6, 6A, 6B, 6C)

28 When establishing a new working area explosion protection must be applied. This should be achieved by erecting either a primary and secondary barrier or a distributed barrier on the appropriate side(s) of the working with the barriers set at the distances stipulated in this specification.

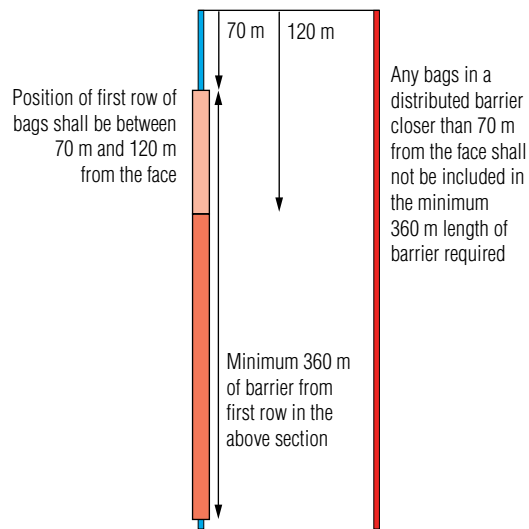

Figure 5 Protection of an established coal face using distributed barriers

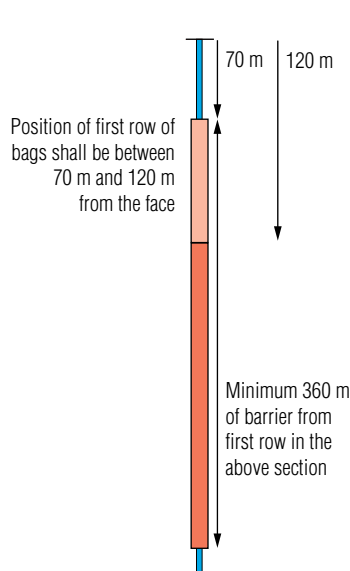

Figure 5a Protection of an established heading in coal using distributed barriers

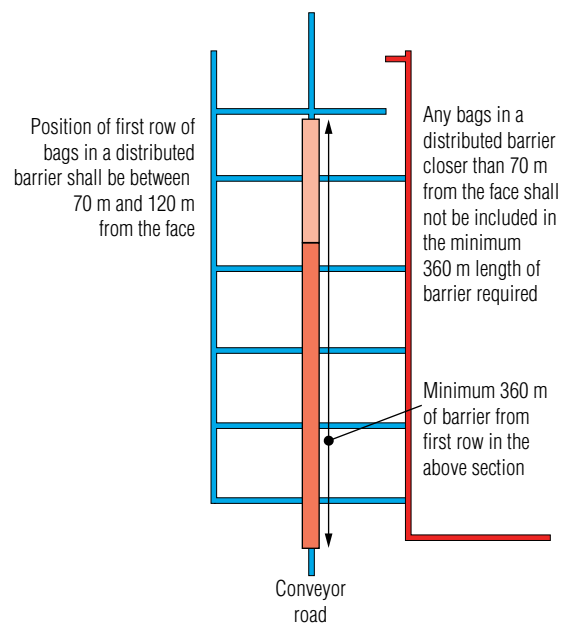

Figure 5b Protection of an established bord and pillar working using a distributed barrier

29 These barriers should be maintained and kept in place until a full barrier of the permitted specification can be erected in the gate roadway. This principle also applies in reverse. When working the retreat method a barrier as outlined above must be established in place prior to the position that a full barrier of the specified type cannot be maintained in the gate roadway. When two or more workings are either setting off or completing working from a common trunk conveyor in close proximity to each other the barriers for one working place can be deemed to offer protection for the other providing the above barrier specifications are maintained. (Fig.6)

30 The above rules will apply to all headings in coal with or without a conveyor.

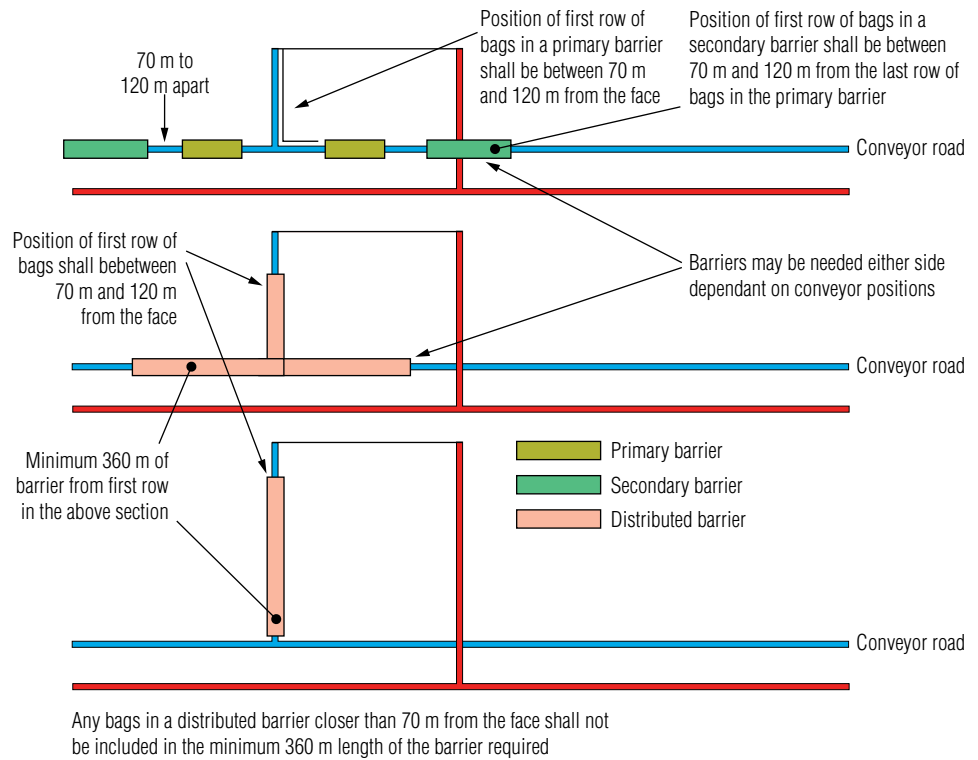

Figure 6 Faces approaching/leaving adjacent roadways

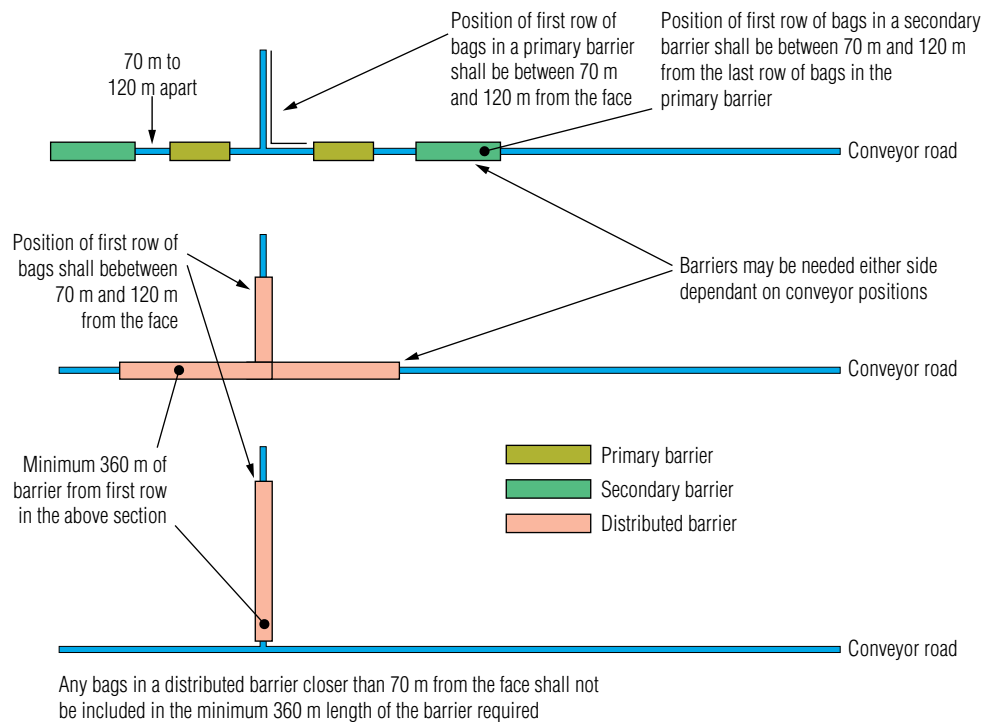

Figure 6a Headings leaving adjacent roadways

Other Cases

31 Defined as any possible points of origin of an explosion, which would be likely to lead to the spread of an explosion to a coal conveyor road. Examples may be certain scourings through goaf and stone drifts, which are approaching, or crossing coal seams or encountering faults or old workings and interconnections between mines.

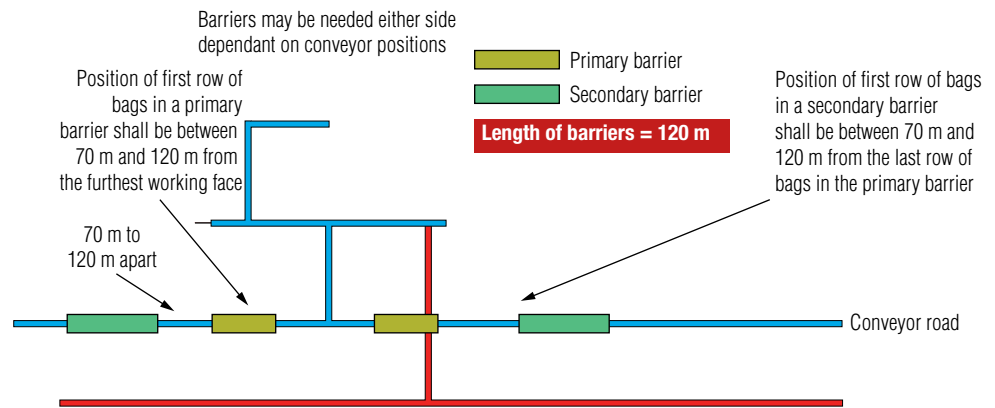

Figure 6b Bord and pillar working leaving adjacent roadways using primary and secondary barriers

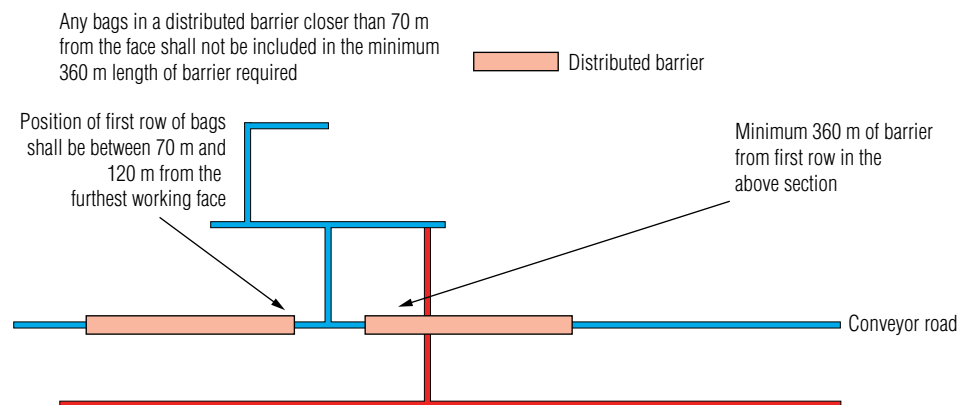

Figure 6c Bord and pillar working leaving adjacent roadways using a distributed barrier

32 In all these cases protection will be afforded by the installation of a primary and a secondary barrier. (Fig. 4).

Specification for a conventional stone dust barrier to the extension of the flame

General

1 Two types of stone dust barriers are used in coalmines, light stone dust barriers and heavy stone dust barriers.

Light Stone Dust Barrier

2 Each barrier should hold not less than 107kg of stonedust/m² of cross section area of the roadway in which is sited.

3 A number of shelves are placed parallel to each other along the roadway. The distance between the nearest parts of the shelves should be not less than 0.9m and not more than 2.1m.

4 Each shelf should rest on brackets that are rigidly attached to the roof supports or roof or sides of the roadway. Each shelf should be loaded with no more than 30kg of stonedust per metre of shelf length.

- 5 No part of the barrier or stonedust places on it should be within 100mm of the roof and the sides of the roadway.
- 6 Each shelf should consist of a number of dust boards that do not exceed 350mm in length that rest on a frame consisting of two parallel members that are at least 150mm in depth and 200mm apart to the outside edge fastened together by connecting pieces.
- 7 The frames should be placed at right angles to the direction of the roadway and rest on the brackets so that the frame is free to slide.
- 8 None of the dust boards or frames should be coupled so that in the event of an explosion they may fly without obstruction.

Wood board type only

A barrier comprises a series of shelves. There are 2 types of shelf the **lightly loaded shelf** and the **heavily loaded shelf**

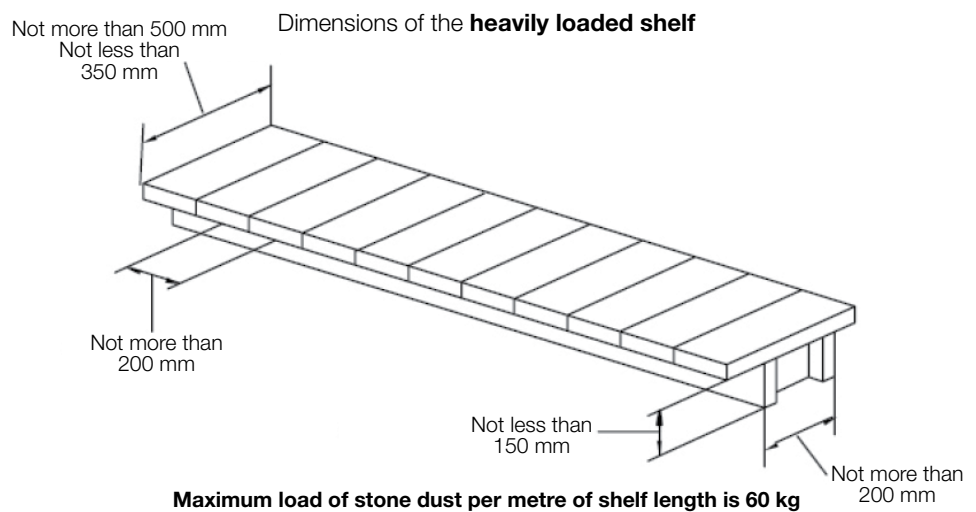
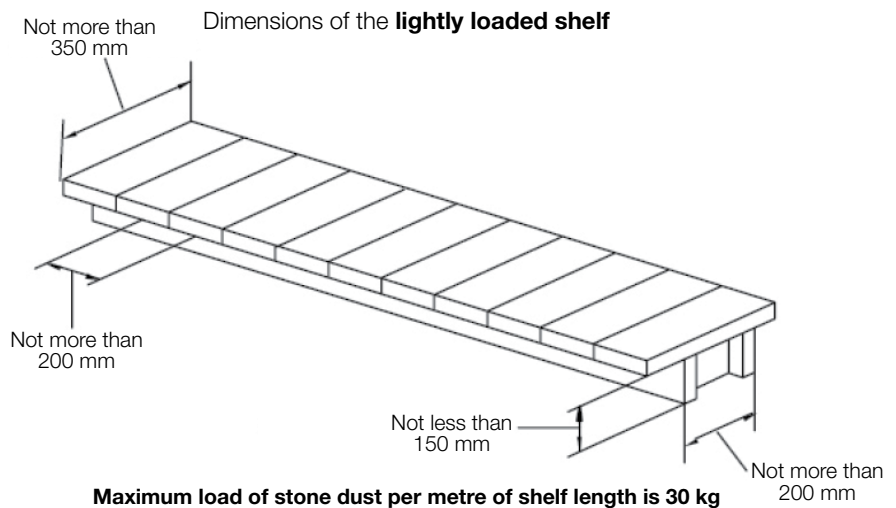

Heavy Stone dust Barrier

- 9 Each barrier shall hold not less than 390kg of stonedust/m² of cross section of the roadway which it is sited.
- 10 A number of shelves are placed parallel to each other along the roadway. The distance between the nearest parts of the shelves should be not less than 1.2m and not more than 2.5m.
- 11 Each shelf should rest on brackets that are rigidly attached to the roof supports or roof or sides of the roadway. Each shelf should be loaded with no more than 60kg of stonedust per metre of shelf length.
- 12 No part of the barrier or stonedust places on it should be within 100mm of the roof and the sides of the roadway.
- 13 Each shelf should consist of a number of dust boards that do not exceed 500mm in length that rest on a frame consisting of two parallel members that are at least 150mm in depth and 200mm apart to the outside edge fastened together by connecting pieces.
- 14 The frames should be placed at right angles to the direction of the roadway and rest on the brackets so that the frame is free to slide.
- 15 None of the dust boards or frames should be coupled so that in the event of an explosion they may fly without obstruction.
- 16 Conventional stonedust barriers should be positioned in roadways following the guidance provided for the positioning of bagged stonedust barriers above.

Specification for a passive water trough barrier to the extension of the flame

General Conditions

- 1 The water barrier should consist of water filled troughs, fixed or mounted in a roadway and should be installed in approximately straight lengths of roadway where the cross-section remains approximately the same size and shape for 25m in length both upstream and downstream of the barrier. In the relevant length of roadway the effectiveness of the barrier should not be impaired by installations and equipment.

Troughs

- 2 All troughs should be fitted with lids to prevent the ingress of foreign material and minimise evaporation.
- 3 Troughs and lids should be constructed from anti-static material of such design and composition as to be readily shattered by the action of the pressure wave in the event of an explosion.
- 4 Each trough should contain the minimum quantity of water and an indication must be provided to show the corresponding minimum water level in the trough. If the troughs are not transparent and the water level cannot be readily seen, then a visual means of indicating the water level must be provided. The minimum quantity of water for large troughs (of 90 litres capacity) should be 80 litres and for small troughs (of 45 litres capacity) 40 litres.

- 5 Troughs should be placed with the longer side of the trough at right angles to the line of the roadway. Exceptionally one trough in a group of more than one trough may be placed longitudinally.
- 6 The specification and performance of water troughs should comply with German Standard DIN 21576 1969, British Coal Spec 733:1991 or a suitable equivalent
- 7 The tests required to meet the specification broadly establish that;
 - (a) troughs remain serviceable for as long as possible under the effect of heat
 - (b) the water contained in troughs is released and adequately distributed under the effects of the dynamic blast pressure of the explosion
 - (c) trough material is flame resistant to a defined flame application. It must not continue to burn independently after removal of flame
 - (d) the material does not allow any static electrical charge, capable of igniting mixtures of air and methane or firing electrical detonators, to be built up or discharged from the surface of the trough
 - (e) the material will not damage health in normal use.

Installation of Troughs

- 8 Installation of the troughs can be achieved in various ways to suit particular requirements. They may be suspended from the roadway support, the strata or mounted on equipment within the roadway. The sides of any troughs suspended inside or mounted on cross members should not have more than 5cm of their height covered by the frame. When troughs are mounted on equipment a form of retaining lip should be provided not less than 3cm in height nor more than 5cm height (the latter in accordance with the first part of this paragraph)
- 9 The equipment used to secure the suspension or mounting of troughs should be designed, installed and maintained as to ensure, in the event of an explosion, the effective dispersion of water by shattering of the troughs.

Configuration of Troughs

- 10 For roadways up to 10m² in cross-sectional area at least 35% of the roadway width should be covered by troughs. For roadways up to 15m² in cross-sectional area at least 50% of the roadway width should be covered by troughs. For roadways over 15m² in cross sectional areas at least 65% of the roadway width should be covered by troughs.
- 11 The sum of the spaces, measured horizontally, between troughs and between the nearest trough and the roadside should not exceed 1.5m. The individual spaces measures horizontally between adjacent troughs or between the nearest trough and the roadside should not exceed 1.2m (Appendix I).
- 12 Where only one layer of troughs is required, the vertical downward distance from the base of each trough to the floor should not be less than 0.8m and not exceed 2.6m. The vertical upward distance from the base of each trough to the roadway roof must not exceed 1.2m

13 Where more than one layer of troughs is required, for example in exceptionally high roadways, then the base of the troughs in the lowest layer must be not more than 2.6m above floor level and not less than 0.8m above floor level. The base of the troughs in the upper layer must be within 1.2m of the roadway roof support at its highest point. The internal distance between the bases of troughs in layers must not exceed 1.2m and there must be a clear space between layers of troughs of not less than 0.1m. (Appendix II, Figure 1).

14 If troughs are arranged in rows less than 1.2m apart, measured along the roadway, troughs in one row must not conceal troughs in the adjacent row from the blast effect of an explosion. In these circumstances, the requirement of paragraph No. 11 need not apply to each row of troughs, but must apply in the case of two adjacent rows closer than 1.2m when considered as a combined row. (Appendix II, Figure 2).

15 No trough should have any part sheltered from the effect of a blast wave by a rigid installation in the roadway e.g., a roof support.

16 In circumstances where proper distribution of water over the cross sectional area of the roadway might be obstructed by equipment, additional troughs should be installed to provide adequate distribution.

Concentrated Barrier Conditions

17 The minimum quantity of water contained in a barrier should be 200 litres/m² of roadway cross-sectional area. Additionally, the quantity of water contained in the barrier should be at least 5 litres/m³ of roadway volume, spread over the length of the barrier. The distance between the first and last row of troughs should not be less than 40m.

18 In roadways protected by concentrated barriers, the distance between adjacent barriers should not exceed 400m.

Distributed Barrier Conditions

19 Water troughs should be arranged in groups. A group should consist of all the troughs whose external edges are contained within a roadway length of 3m. (Appendix II, Figure 2). The minimum quantity of water in a group should be 1 litre/m³ of the roadway volume between adjacent groups.

20 If a roadway is protected by a distributed barrier only, then the total quantity of water must not be less than 200 litres/m² of the roadway cross section. Such a barrier should comprise at least three groups of water troughs. The maximum distance between groups should be 30m.

21 In gate roadways and headings protected only by distributed barriers, the maximum distance of 30m between groups of troughs should be closed up initially so that a total quantity of water, equal to 200 litres/m² of roadway cross section, is introduced as soon as is practicable. Thereafter normal spacing between groups of troughs can be followed. (Appendix III, Figure 1).

22 For both headings and faces the distance from the face to the nearest group of troughs in a distributed barrier should not exceed 35m. Should the presence of installed apparatus and equipment prevent this requirement being met, then either

- (a) The group of troughs nearest to the longwall faceline or face of the heading may be contained within a roadway length of 8m providing the nearest trough should not exceed 35m from the face, or

- (b) a triggered dust barrier to the extension of flame should be installed between the face and the group of water troughs nearest to the face, which then may be up to 200m from the face.

Junctions & Special Case

23 Concentrated barriers should generally be used for the protection of main roadways only. The sole exception envisaged is in the case of a new gate roadway or heading being driven off a main roadway. If a concentrated barrier is being installed in such a gate roadway or heading as it is being driven then it can be allowed to remain there.

24 The subsequent protection of the gate roadway or heading should be by a distributed barrier in conjunction with the concentrated barrier with the first group of troughs being not more than 30m from the concentrated barrier. (Appendix III, Figure 1).

25 In the case of junctions where all the branch roadways in the immediate vicinity of the junction are protected by concentrated barriers, the maximum distance from the junction to the nearest trough of a concentrated barrier in each of the branch roadways should not exceed 50m. Therefore, the maximum distance between concentrated barriers would not exceed 100m. (Appendix III, Figure 2).

26 In the case of junctions where all branch roadways in the immediate vicinity of the junction are protected by distributed barriers, the maximum distance from the junction to the nearest group in each of the branch roadways should not exceed 15m. Therefore, the maximum distance between groups would not exceed 30m (as shown in Appendix III, Figure 3).

Transition from One Type of Barrier to Another

27 In the case of junctions where one or more of the branch roadways are protected by distributed barriers and the others by concentrated barriers then the maximum distance between adjacent troughs of the two types should not exceed 60m (as shown in Appendix III, Figure 4).

28 There should be a minimum distance of 100m between a water barrier and the nearest stone dust barrier (as shown in Appendix III, Figure 5).

29 If both concentrated and distributed passive water trough barriers are installed in the same roadway, the distance from the concentrated barrier to the first group of troughs in the distributed barrier should not exceed 30m (as shown in Appendix III, Figure 6).

Appendix I

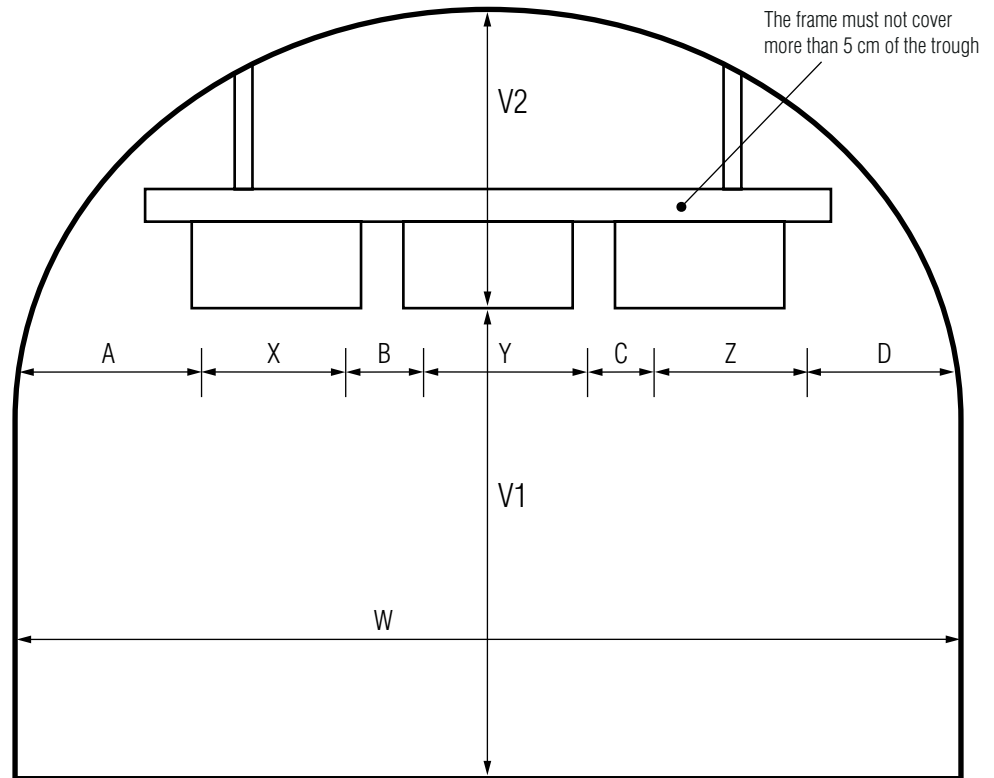

- 1 For roadways up to 10m^2 , $X+Y+Z$ must cover at least 35% of W .
- 2 For roadways up to 15m^2 , $X+Y+Z$ must cover at least 50% of W .
- 3 For roadways in excess of 15m^2 , $X+Y+Z$ must cover at least 65% of W .
- 4 Distance A or B or C or D must not exceed 1.2m.
- 5 The total distance of $A+B+C+D$ etc must not exceed 1.5m
- 6 Distance V_1 must not be less than 0.8m and not exceed 2.6m.
- 7 Distance V_2 should not exceed 1.2m. If this distance is exceeded, additional troughs should be placed above and they may be in excess of 2.6m above floor level, but there should not be more than 1.2 between the base of layers of troughs.

Figure 1 Passive water trough barriers

Appendix II

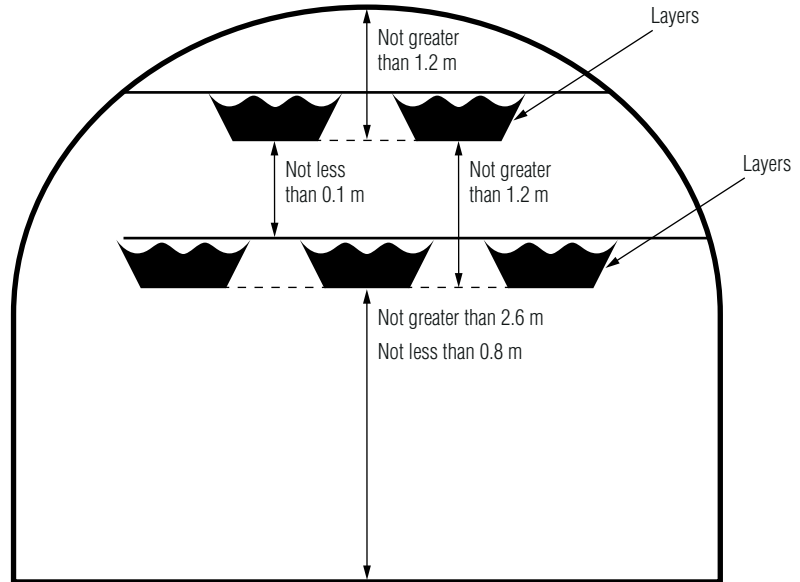

Figure 1 Roadway section

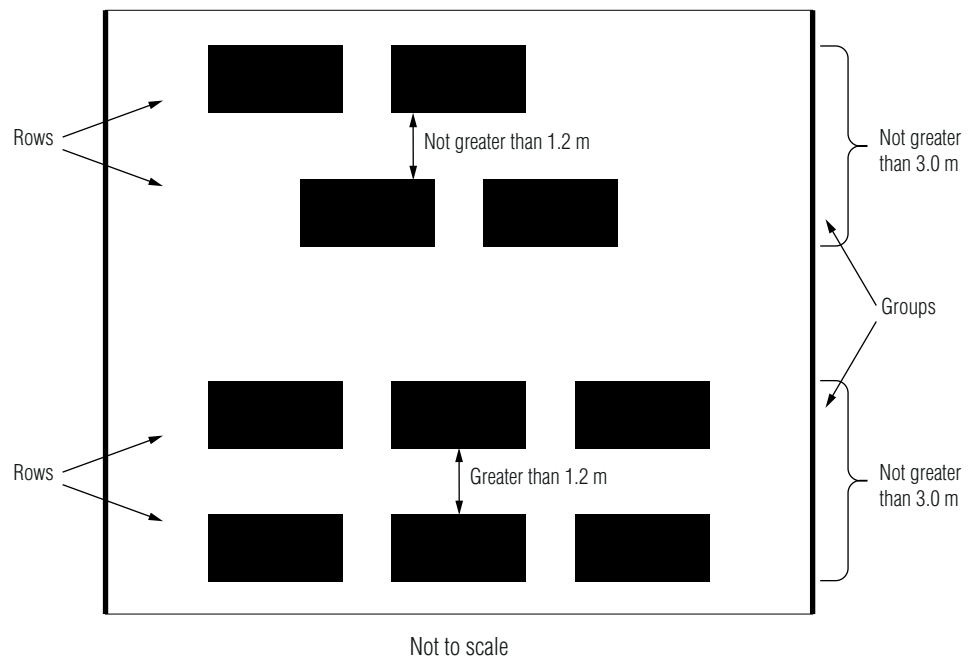

Figure 2 Roadway plan

Appendix III

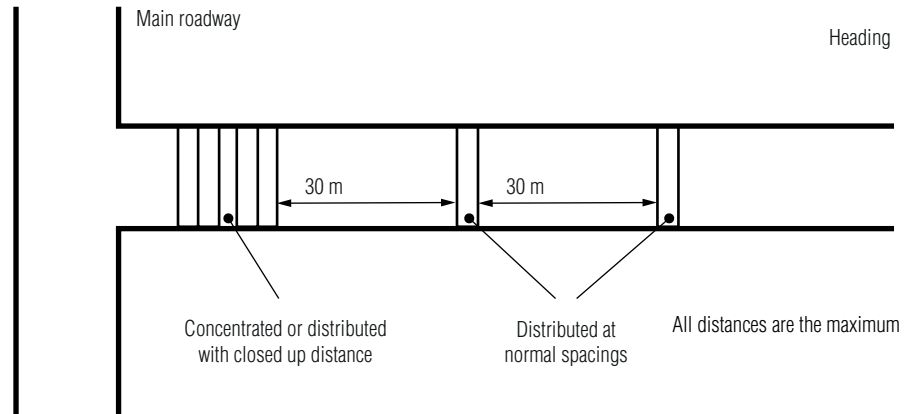

Figure 1 Start of heading (Paragraphs 21 and 24)

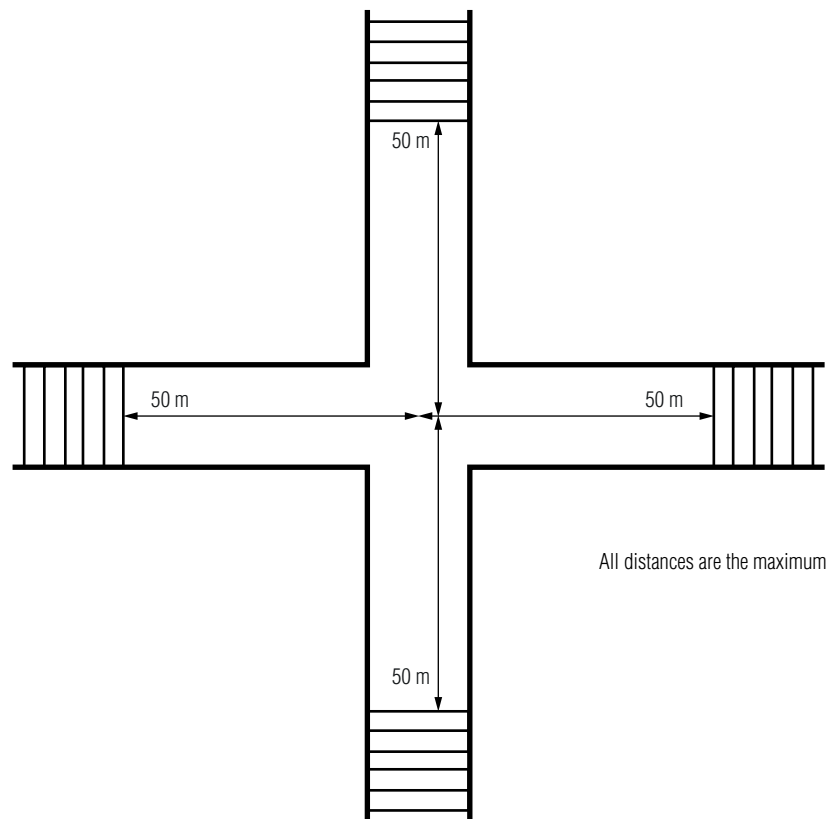

Figure 2 Concentrated barriers from a junction (Paragraph 25)

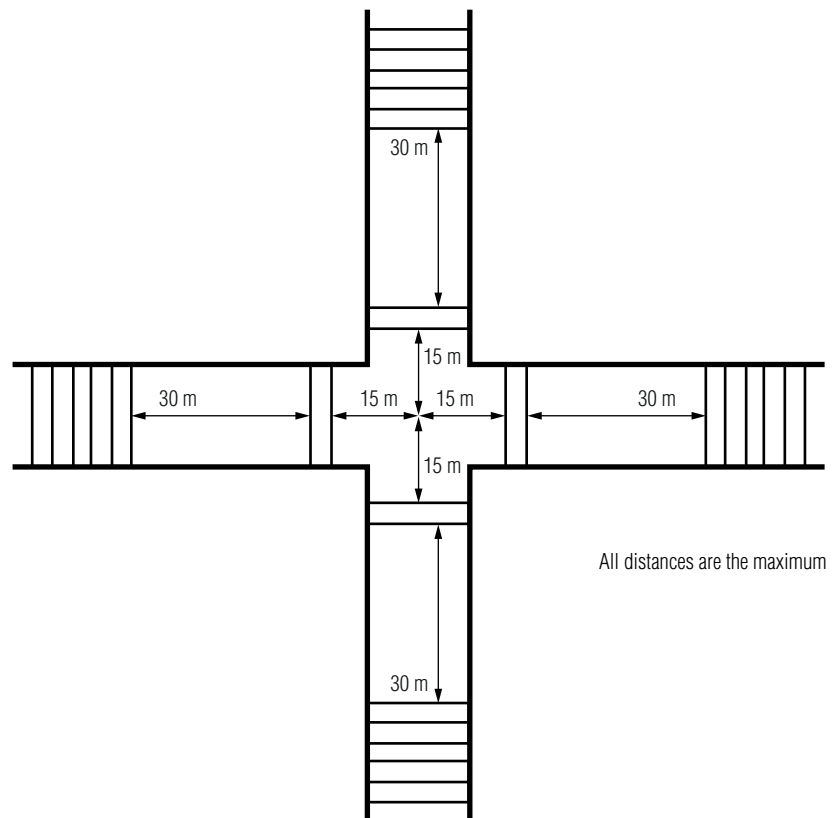

Figure 3 Distributed barriers from a junction (Paragraph 26)

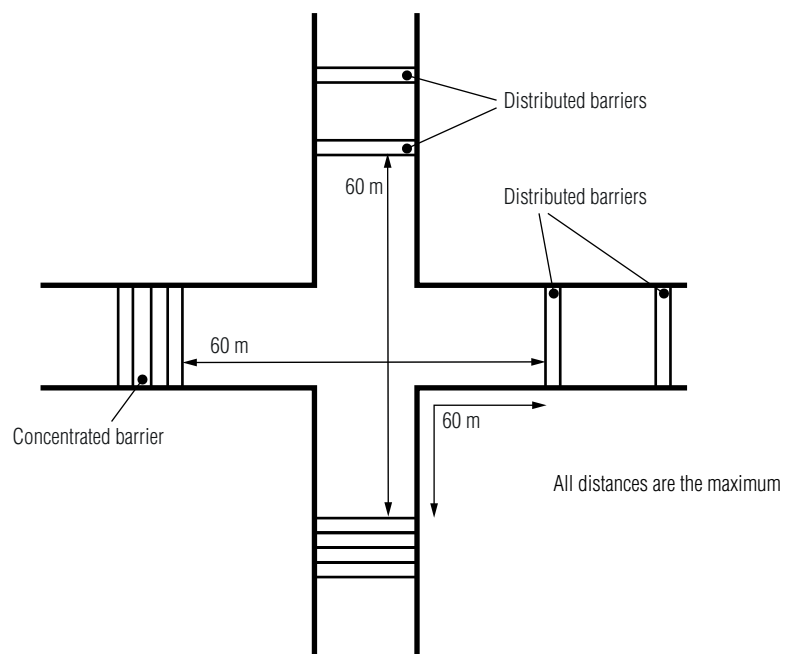

Figure 4 Distributed and concentrated barriers from a junction (Paragraph 27)

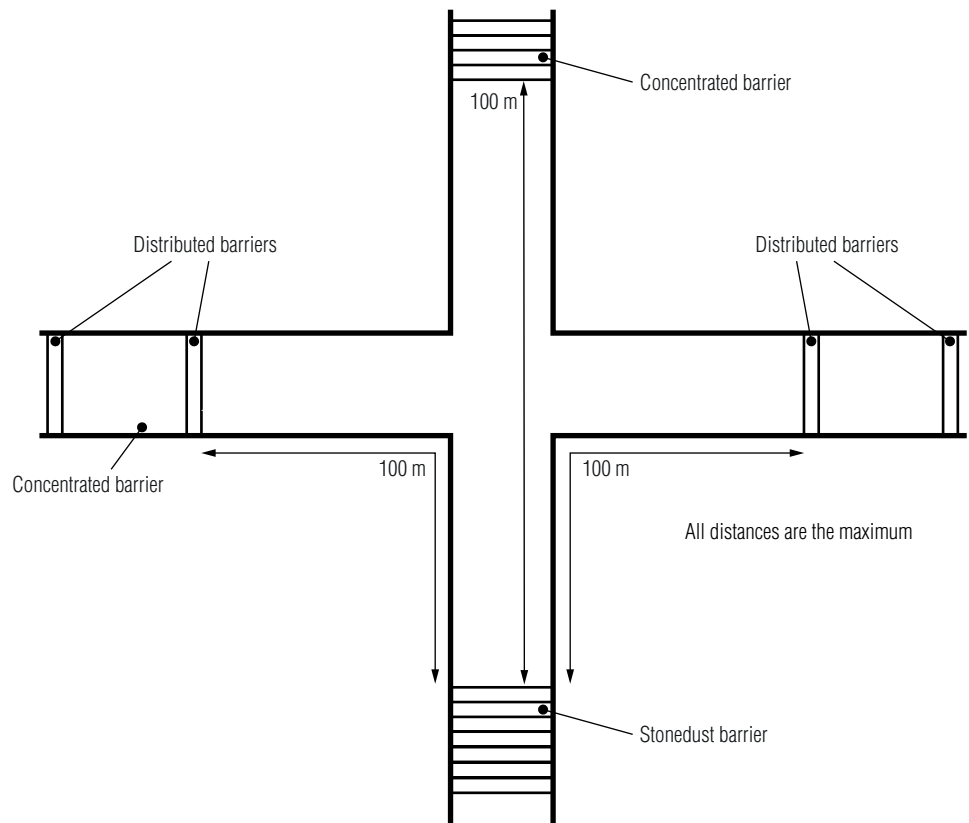

Figure 5 Distance of water barriers from stonedust barriers (Paragraph 28)

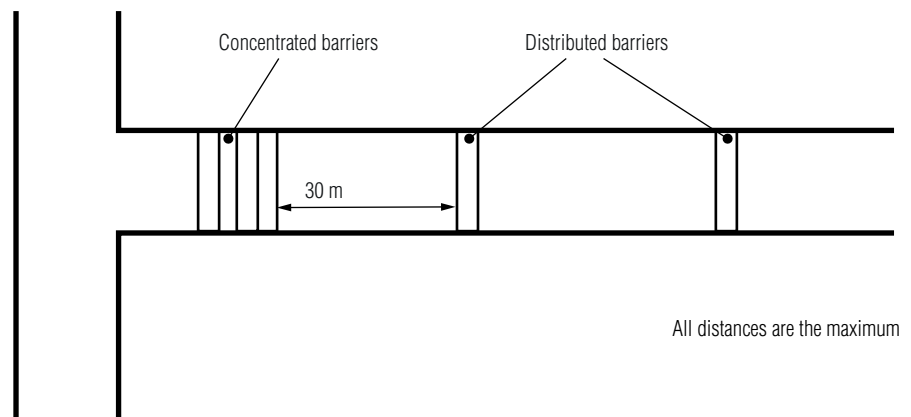

Figure 6 Concentrated and distributed barriers in the same roadway (Paragraph 29)